

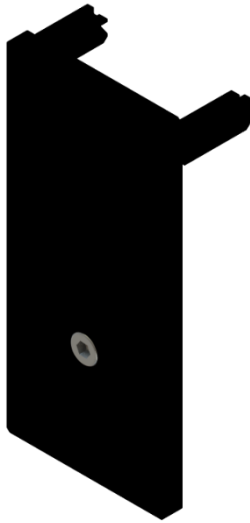

# Profilabschluss

## Profile end cover

eepos  
cranes



### Produktmerkmal Product Characteristics

- Wird durch selbstschneidende Schraube in der Profillinennut befestigt  
Is fixed in the internal profile groove by using a self-tapping screw
- Verhindert das Eindringen von Verunreinigungen  
Prevents the ingress of impurities
- Saubere Abdeckung der Profilschnittkante  
Clean covering of the profile edge
- Neutrale Ausführung durch abtrennbares eepos-Logo möglich  
Neutral design possible by detachable eepos logo

### Ausführung Type

Profilabschluss Profile end cover	Eigengewicht Weight	Artikelnummer Item no.
XS	0,08 kg 0.18 lb	0012700
S	0,11 kg 0.24 lb	0012701
M	0,15 kg 0.33 lb	0012702
L	0,18 kg 0.40 lb	0012703
XL	0,21 kg 0.46 lb	0012704
XXL	0,24 kg 0.53 lb	0012705

### Einbausituation Assembly Situation

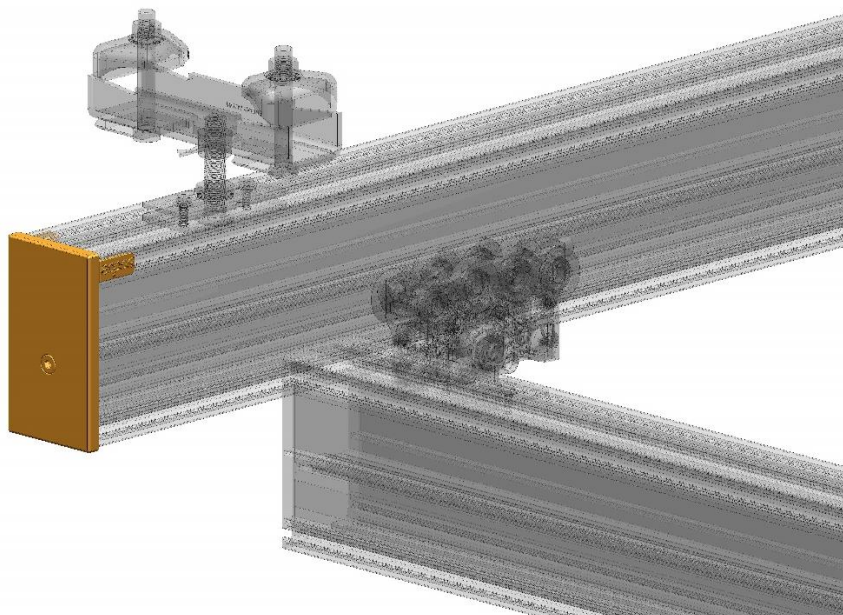

Unterliegt keinem Änderungsdienst. Nur zur Information  
Not subject to revision. Only for information

## Produktdatenblatt

### Product Data Sheet

eepos GmbH  
Zum Scherbusch 1  
51674 Wiehl-Marienhagen  
Deutschland

Tel.: +49 (0) 2261 54637-0  
Fax.: +49 (0) 2261 54637-129  
info@eepos.de  
www.eepos.de

S. 1/2

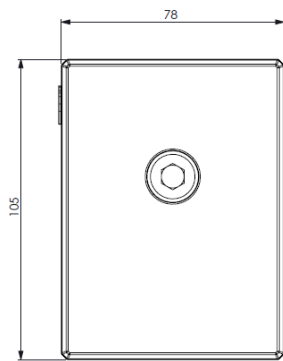

XS

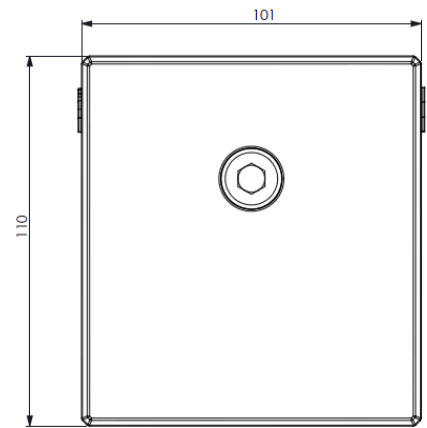
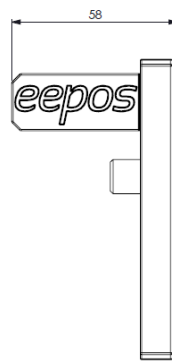

S

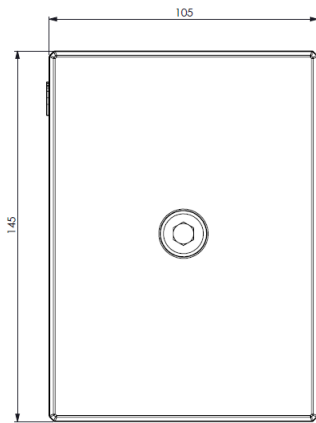

M

Schlüsselweite 8  
Anzugsmoment 59 Nm  
Width across flats 8  
Tightening torque 59 Nm

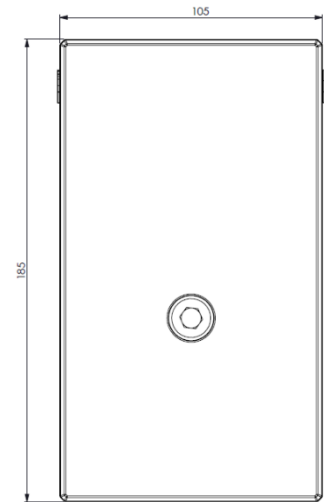

L

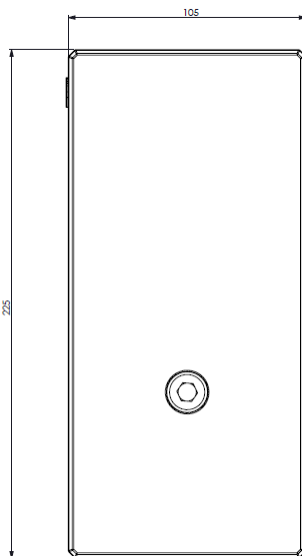

XL

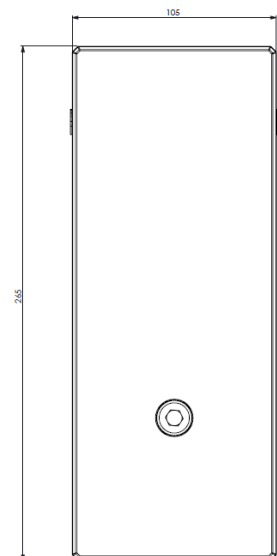

XXL